



Zakázka : IMRE08
Datum : 09.08.2006

Objednávka č. :

Vazník : S1

Strana : 1

MiTek Industries spol. s
Drážní 7, 627 00 Brno,
Tel.05-45 51 32 81 Fax05-45 51 32 97

Poč. vrst : 1
Poč. : 24 ks.
Kubatura : 0.1889 m³

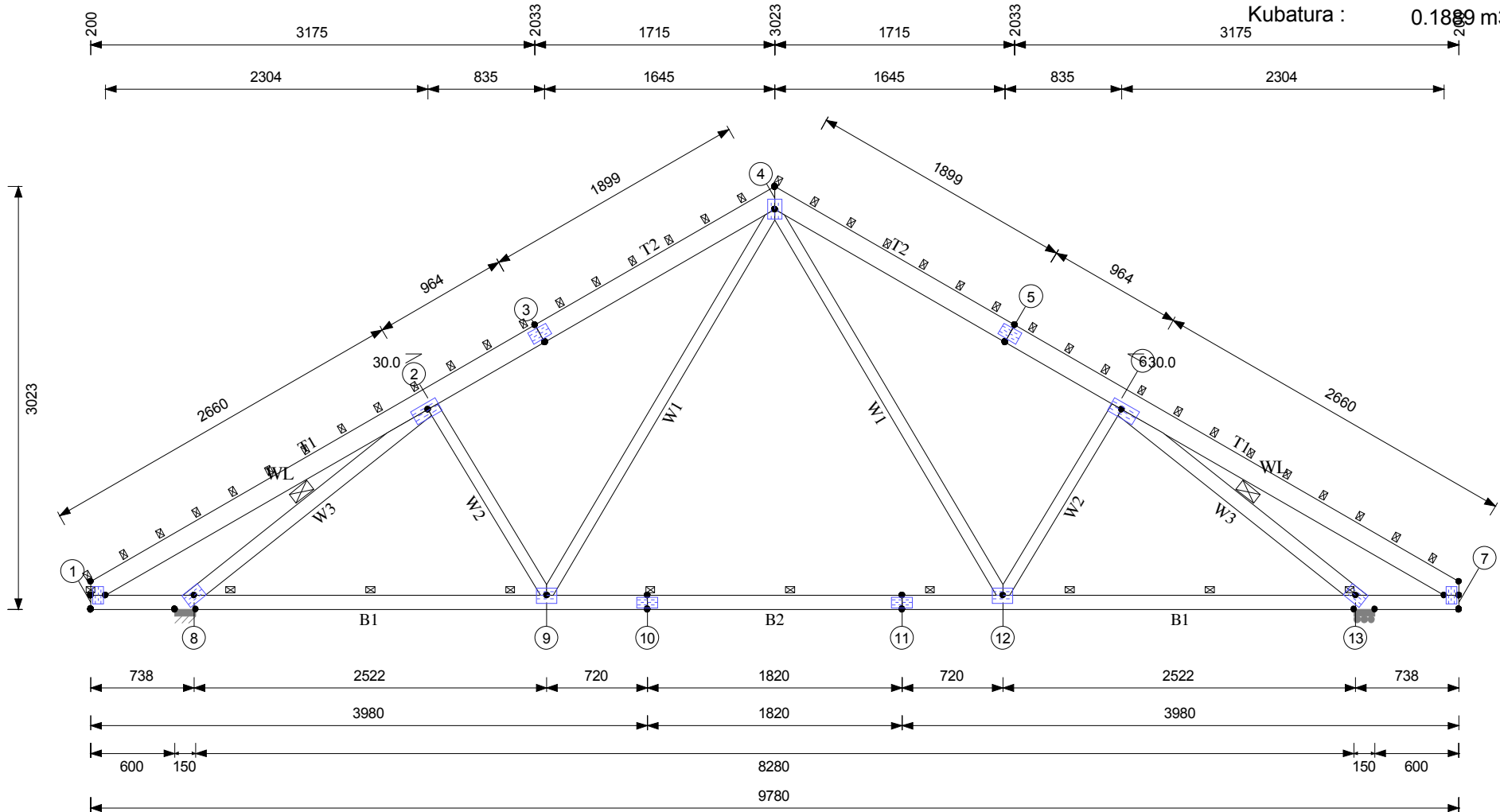

M 1:43

HP 50x140 SM-JD SI; DP 50x100 SM-JD SI; DIAG. 50x80 SM-JD SI; DIAG. W3, W3 50x100 SM-JD SI; 1 - Znás.vaz.

Zakázka : IMRE08

Vazník : S1

Objenávka č.

Datum : 09.08.2006

Celková kubatura : 4.8912 m³

Kubatura dřeva na vazník : 0.2038 m³

Počet vazníků : 24

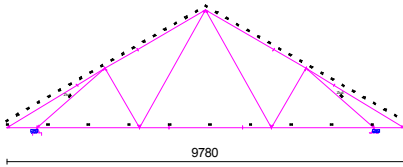

Prvek : T2

30.00

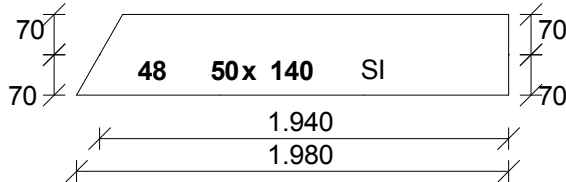

Skladová délka : 2.000 metru.

Prvek : T1

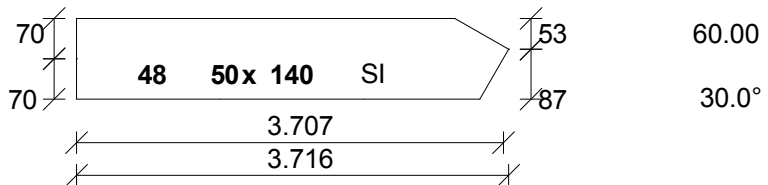

Skladová délka : 4.000 metru.

Prvek : B2

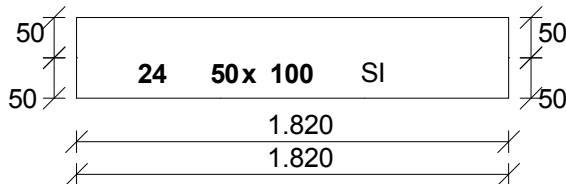

Skladová délka : 2.000 metru.

Prvek : B1

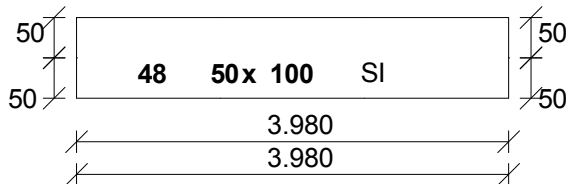

Skladová délka : 4.000 metru.

Prvek : W3

81.51

7.4°

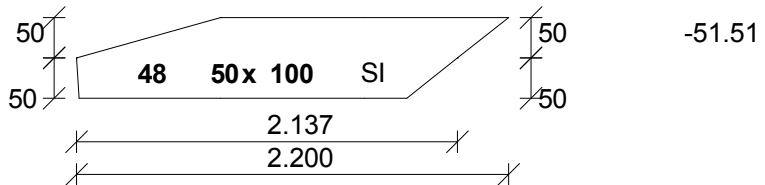

Skladová délka : 2.500 metru.

Prvek : W1

60.55

59.5°

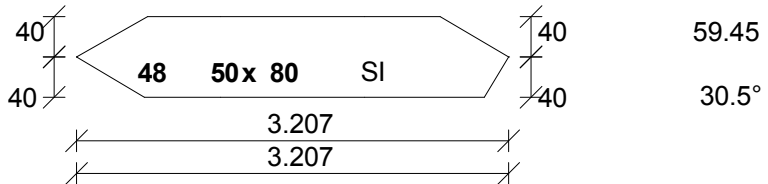

Skladová délka : 4.000 metru.

Prvek : W2

1.12

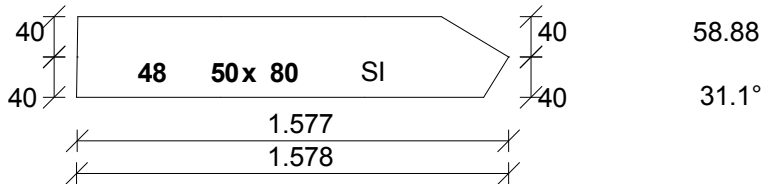

Skladová délka : 1.600 metru.

Zakázka: **IMRE08**
 Popis zak.:
 Zákazník: **lavicky**

Vaz.: S1

MiTek Industries spol. s r.o.
 Drážní 7, 627 00 Brno,
 Tel.: 05-45 51 32 81 Fax.: 05-45 51 32 97

MI
 Strana: 3

M 1:124

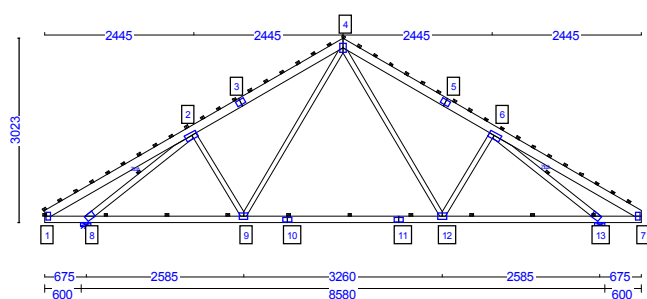

Detaily spojů

Vaz.: S1

Popis zak.:

Tl. řeziva: 50 mm
 Rozteč vaz.: 995 mm
 Počet vrstev: 1
 Počet vaz.: 24

1 | **GNA20 813 76 x 122** | M 1:5

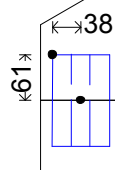

2 | **GNA20 1020 105 x 204** | M 1:5

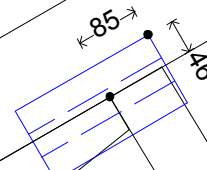

3 | **T150 815 88 x 146** | M 1:5

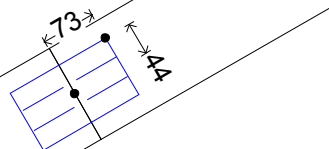

4 | **GNA20 1015 105 x 142** | M 1:5

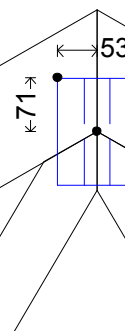

9 | **GNA20 1015 105 x 142** | M 1:5

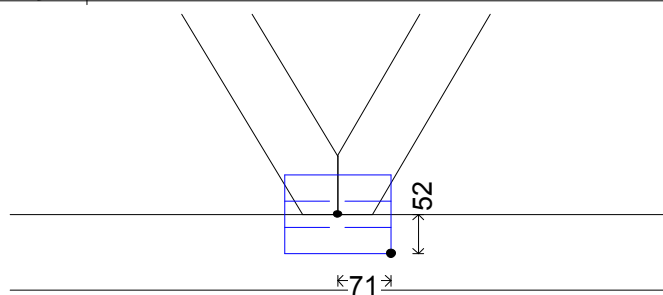

10 | **T150 715 73 x 146** | M 1:5

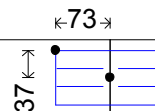

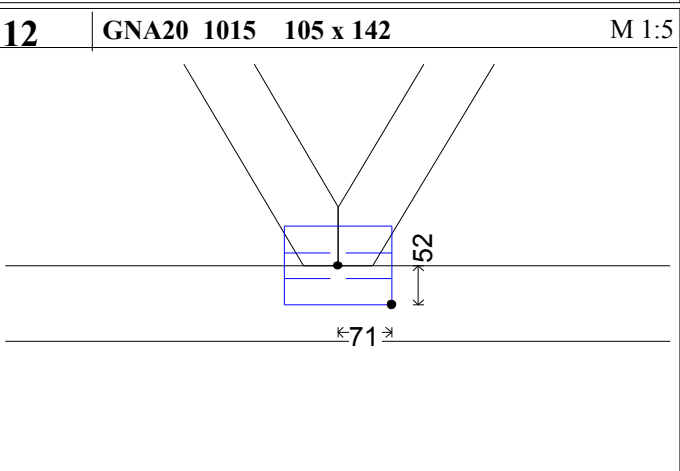
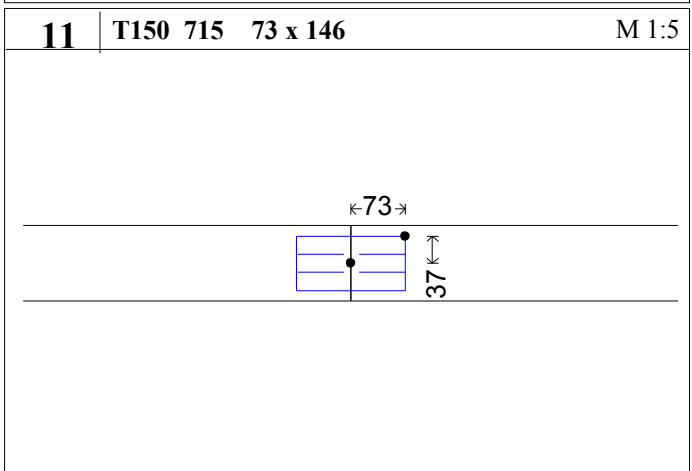
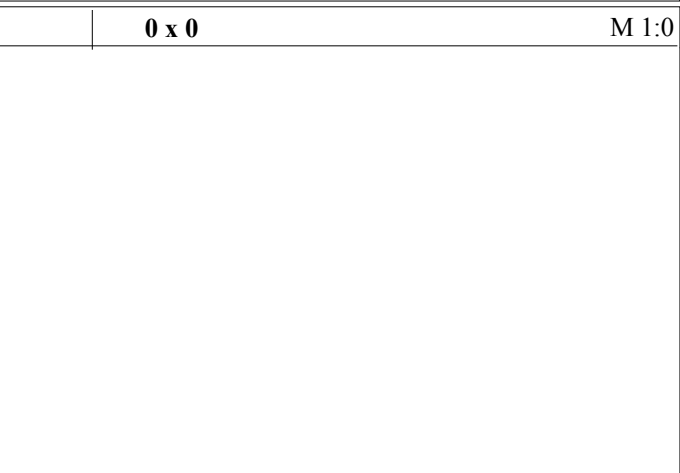
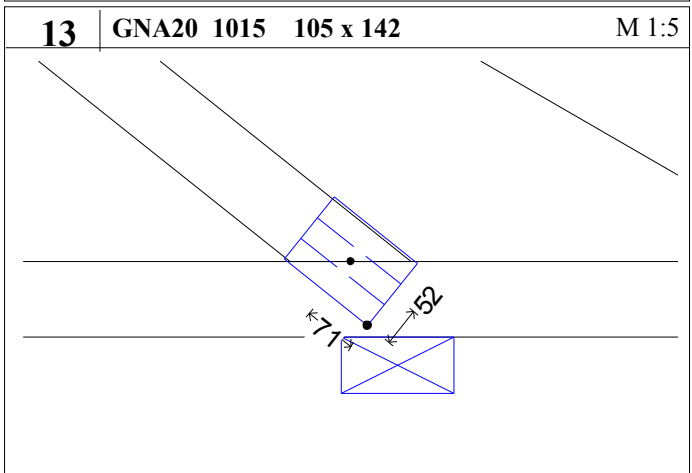
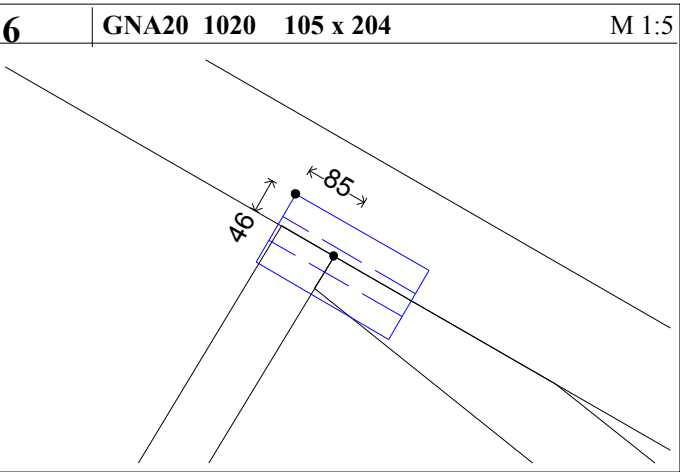
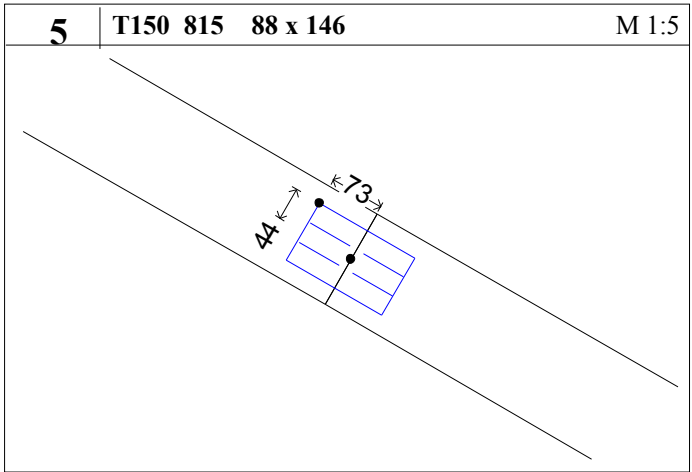
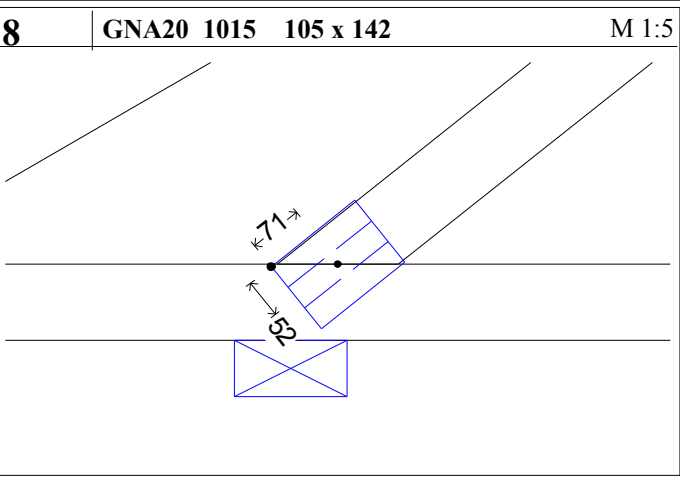
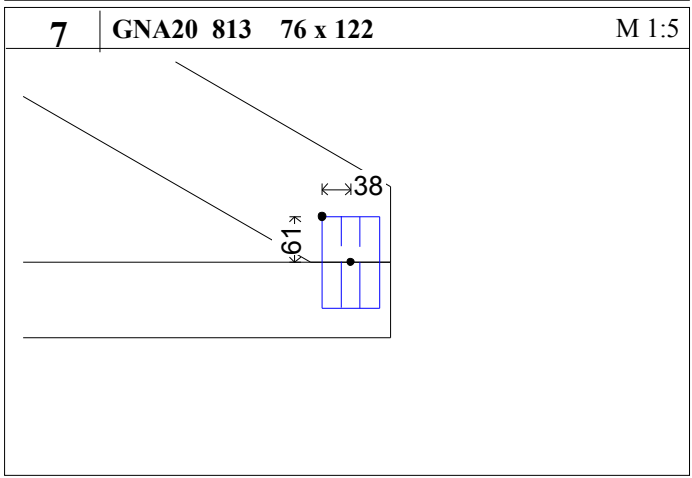



Zakázka : IMRE08

Objednávka č. :

Vazník : S1A

MiTek Industries spol. s

Drážní 7, 627 00 Brno,

Tel.05-45 51 32 81 Fax05-45 51 32 97

Datum : 09.08.2006

Strana : 5

Poč. vrst : 1
Poč. : 8 ks.
Kubatura : 0.1889 m³

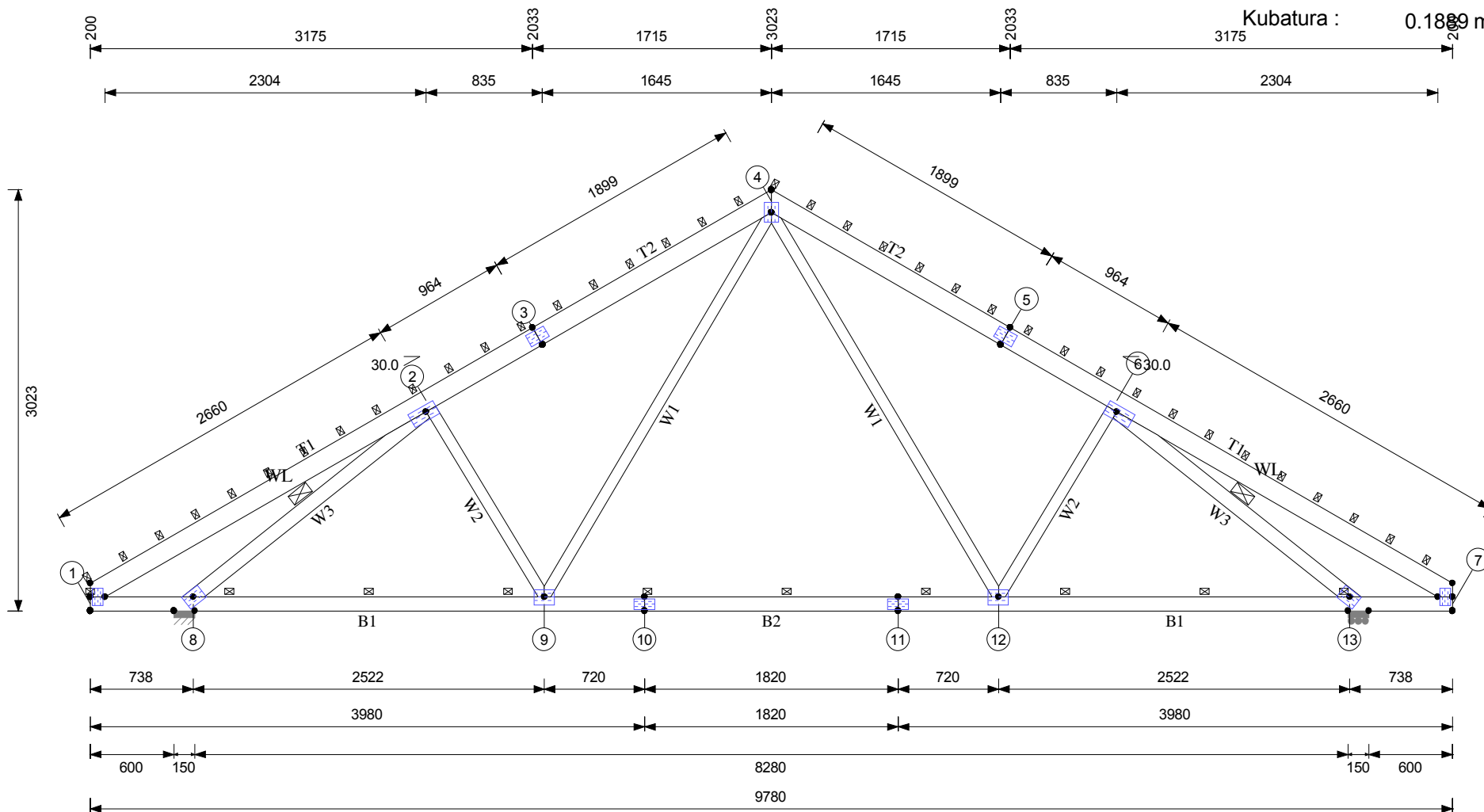

M 1:43

HP 50x140 SM-JD SI;DP 50x100 SM-JD SI;DIAG. 50x80 SM-JD SI;DIAG. W3, W3 50x100 SM-JD SI;1 - Znás.vaz.

Zakázka : IMRE08

Vazník : **S1A**

Objenávka č.

Datum : 09.08.2006

Celková kubatura : 1.6304 m³

Kubatura dřeva na vazník : 0.2038 m³

Počet vazníků : 8

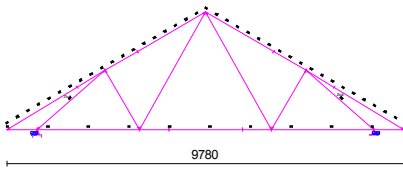

Prvek : **T2**

30.00

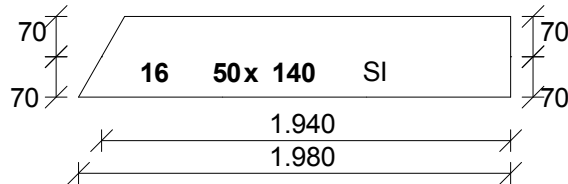

Skladová délka : 2.000 metru.

Prvek : **T1**

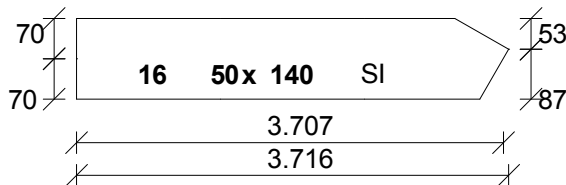

60.00

30.0°

Skladová délka : 4.000 metru.

Prvek : **B2**

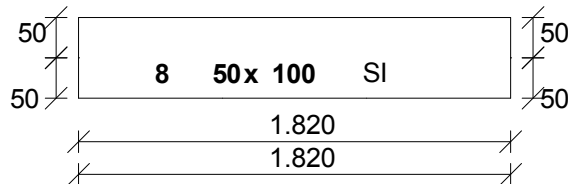

Skladová délka : 2.000 metru.

Prvek : **B1**

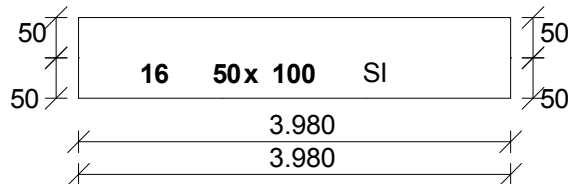

Skladová délka : 4.000 metru.

Prvek : **W3**

81.51

7.4°

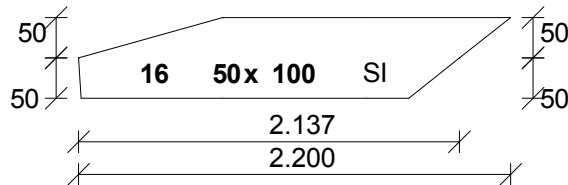

-51.51

Skladová délka : 2.500 metru.

Prvek : **W1**

60.55

59.5°

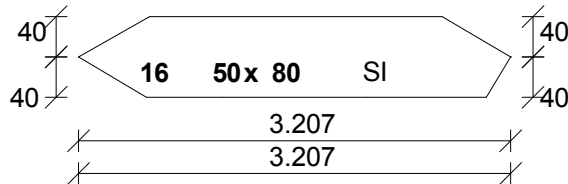

59.45

30.5°

Skladová délka : 4.000 metru.

Prvek : **W2**

1.12

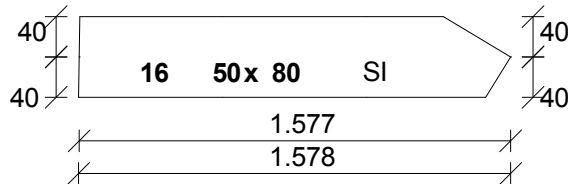

58.88

31.1°

Skladová délka : 1.600 metru.

M 1:124

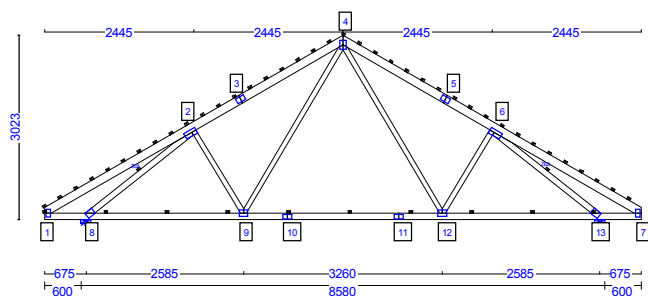

Detaily spojů

Vaz.: S1A

Popis zak.:

Tl. řeziva: 50 mm
 Rozteč vaz.: 995 mm
 Počet vrstev: 1
 Počet vaz.: 8

1 | GNA20 813 76 x 122 | M 1:5

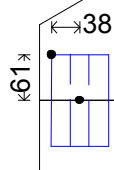

2 | GNA20 1020 105 x 204 | M 1:5

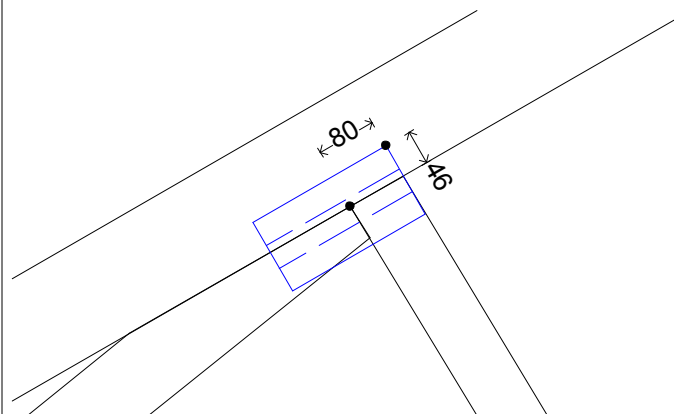

3 | T150 815 88 x 146 | M 1:5

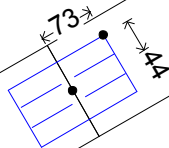

4 | GNA20 1015 105 x 142 | M 1:5

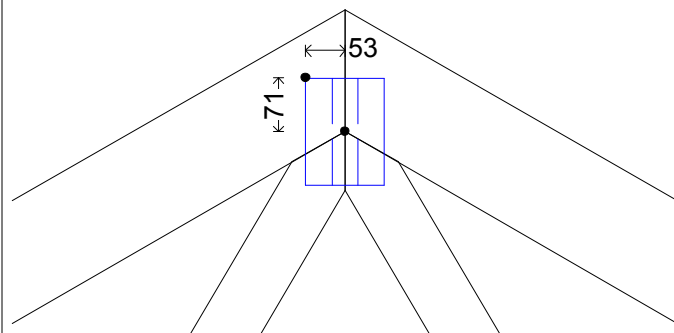

9 | GNA20 1015 105 x 142 | M 1:5

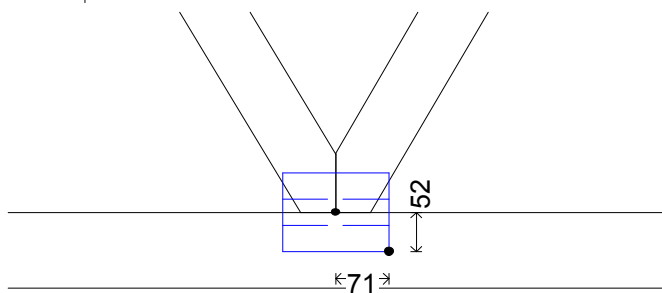

10 | T150 715 73 x 146 | M 1:5

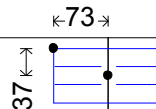

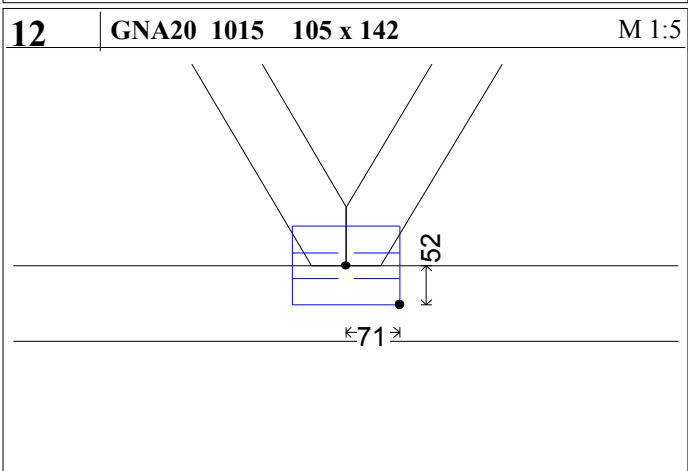
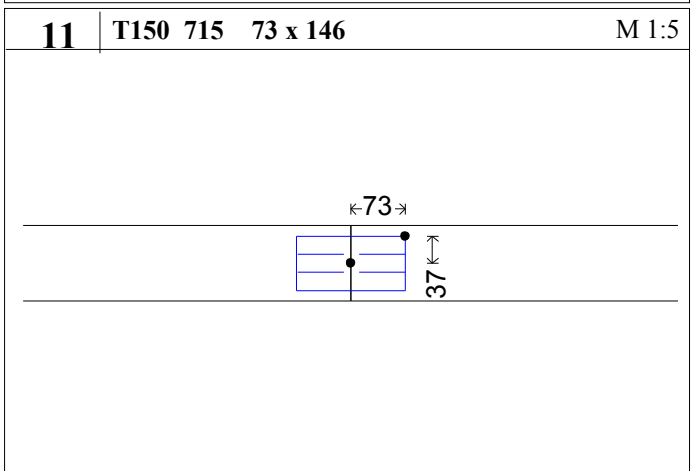
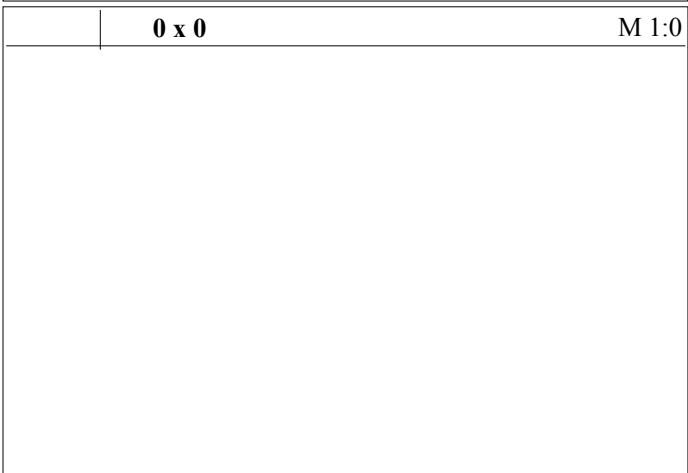
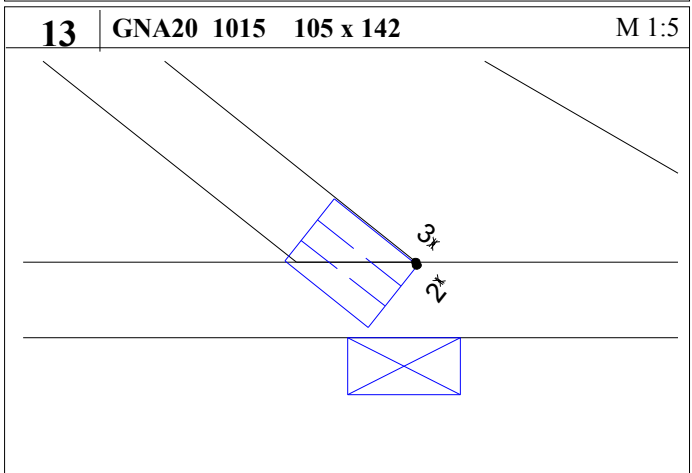
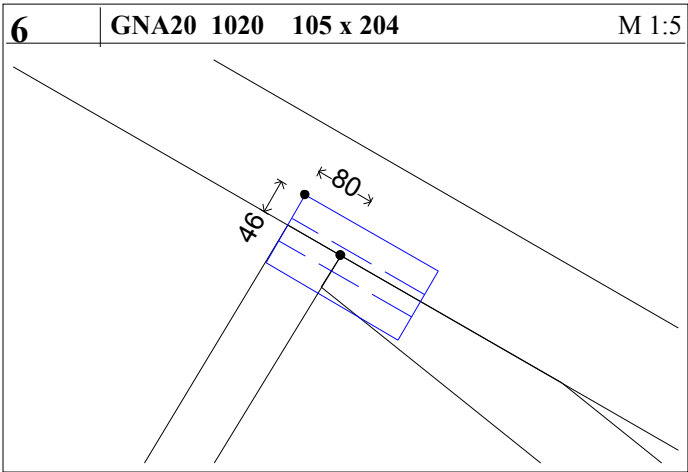
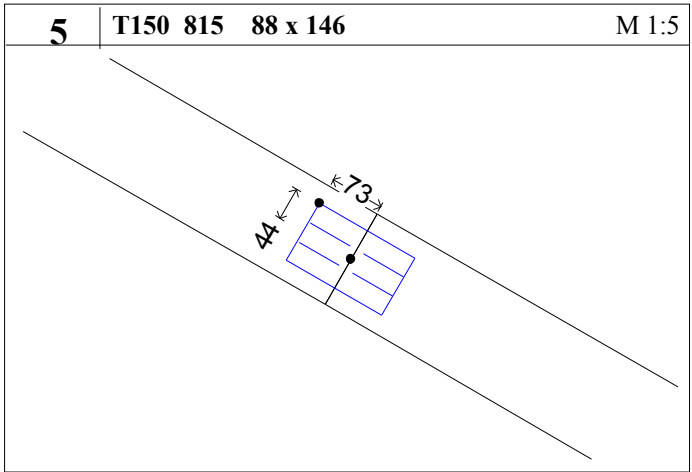
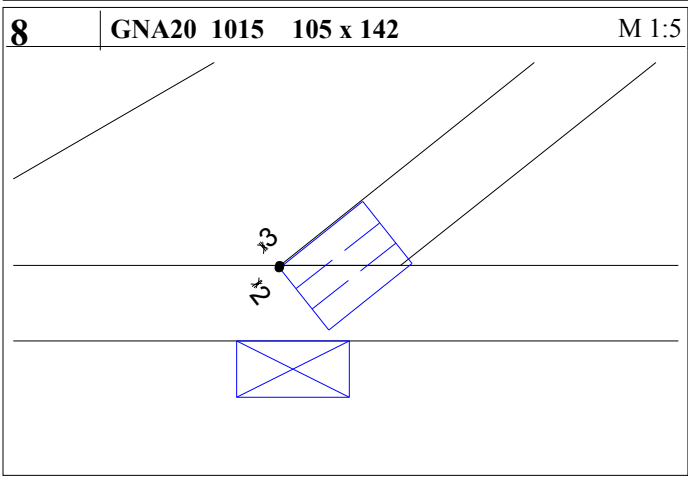
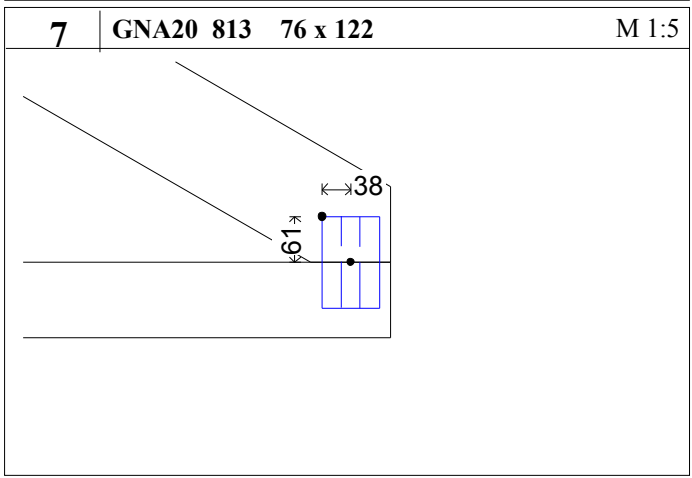



Zakázka : IMRE08
Datum : 09.08.2006

Objednávka č. :

Vazník : S2

Strana : 9

MiTek Industries spol. s
Dražní 7, 627 00 Brno,
Tel.:05-45 51 32 81 Fax05-45 51 32 97

Poč. vrst : 1
Poč. : 4 ks.
Kubatura : 0.1733 m³

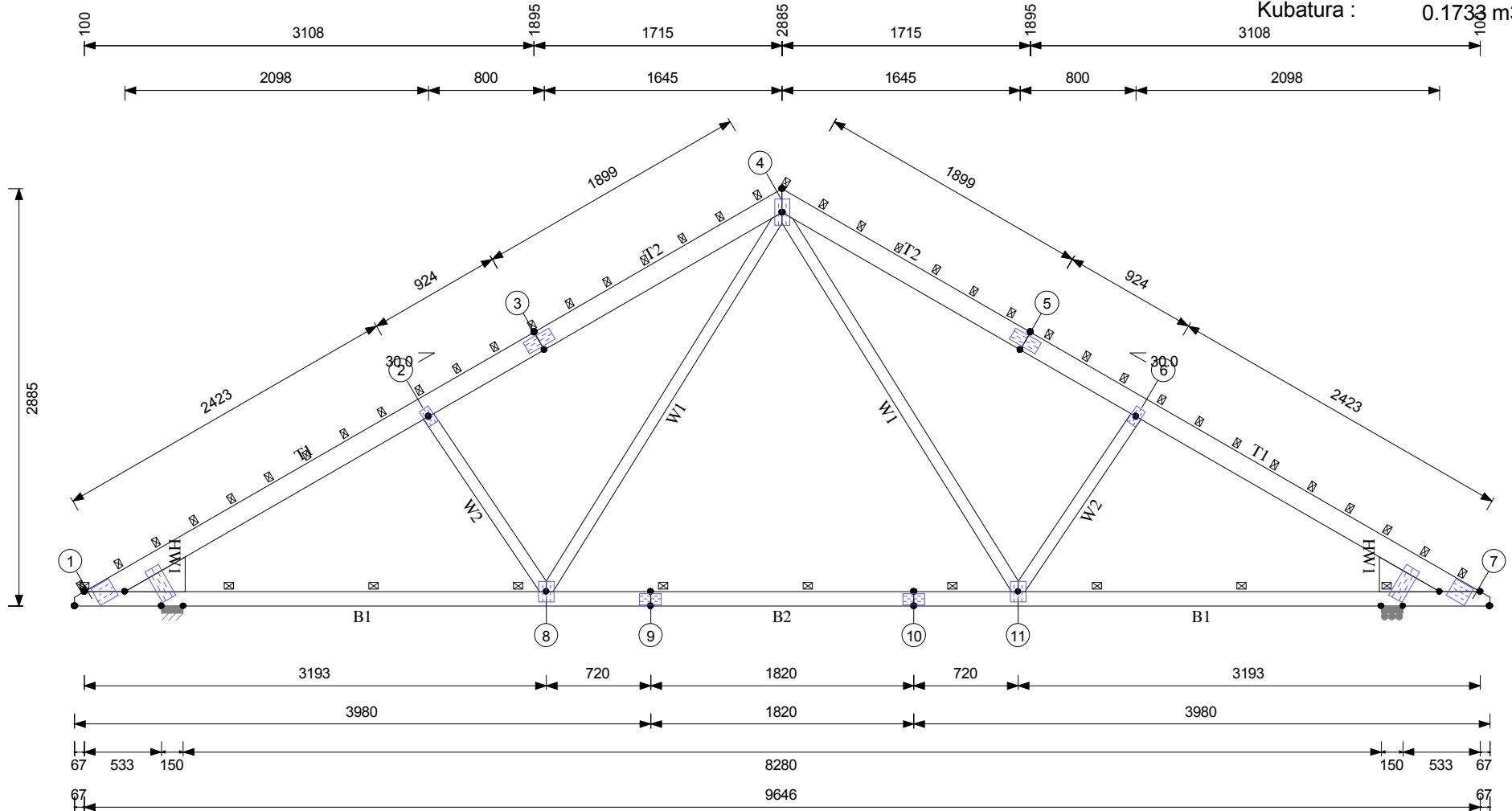

M 1:42

HP 50x140 SM-JD SI;DP 50x100 SM-JD SI;DIAG. 50x80 SM-JD SI;1 - Znás.vaz.

Zakázka : IMRE08

Vazník : **S2**

Objenávka č.

Datum : 09.08.2006

Celková kubatura : 0.7696 m³

Kubatura dřeva na vazník : 0.1924 m³

Počet vazníků : 4

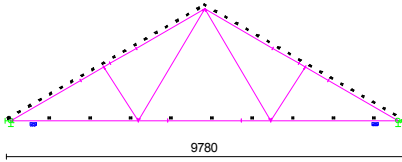

Prvek : **T2**

30.00

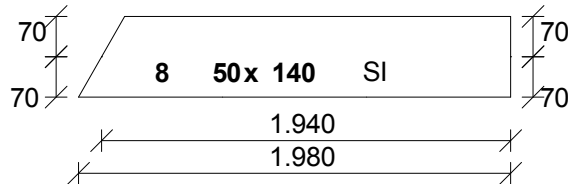

Skladová délka : 2.000 metru.

Prvek : **T1**

60.00

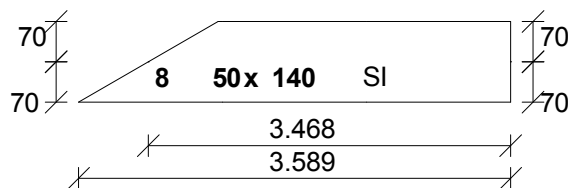

Skladová délka : 4.000 metru.

Prvek : **B2**

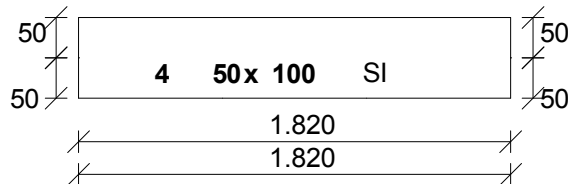

Skladová délka : 2.000 metru.

Prvek : **B1**

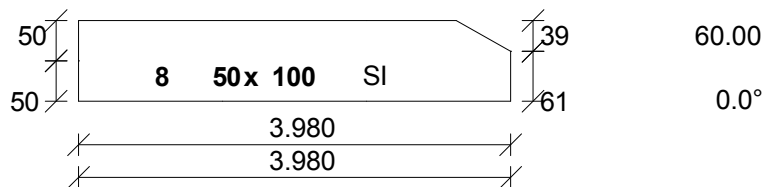

Skladová délka : 4.000 metru.

Prvek : **W1**

61.86

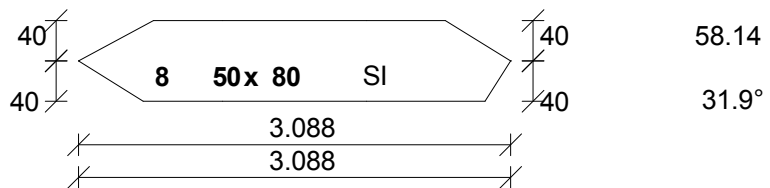

Skladová délka : 4.000 metru.

Prvek : **W2**

3.93

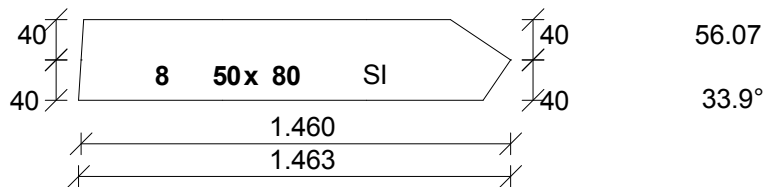

Skladová délka : 1.500 metru.

Prvek : **HW1**

60.00

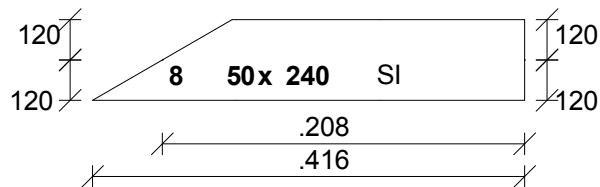

Skladová délka : .600 metru.

Zakázka: **IMRE08**
Popis zak.:
Zákazník: **lavicky**

Vaz.: S2

MiTek Industries spol. s r.o.

Drážní 7, 627 00 Brno,

Tel.: 05-45 51 32 81

Fax.: 05-45 51 32 97



Strana:

M 1:124

Detaily spojů

Vaz.: S2

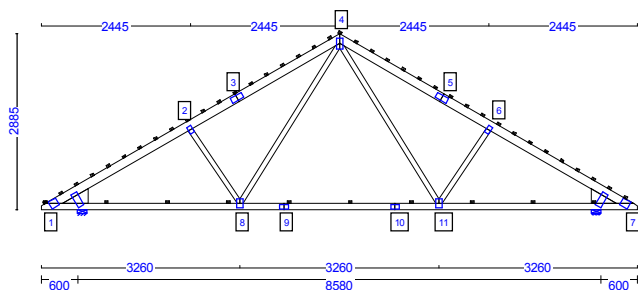

Popis zak.:

Tl. řeziva:	50 mm
Rozteč vaz.:	1,000 mm
Počet vrstev:	1
Počet vaz.:	4

M 1:10

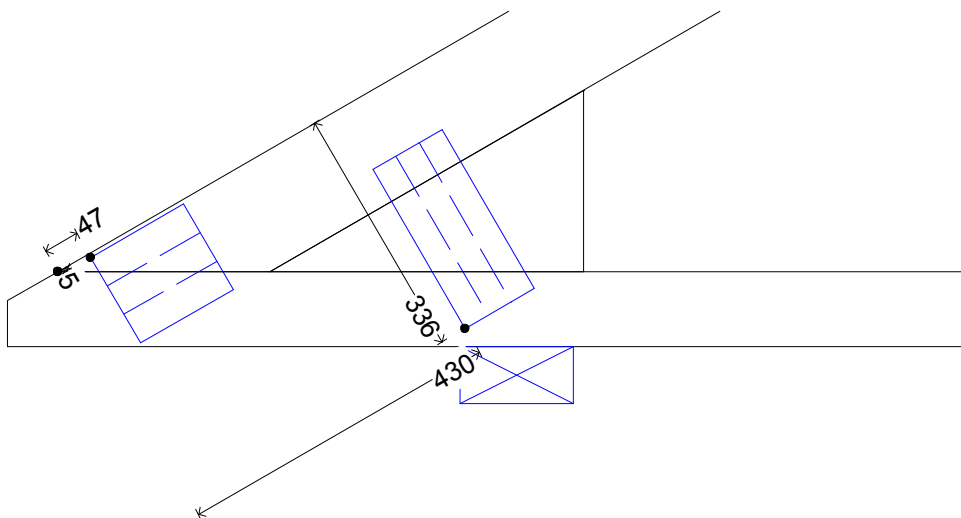

GNA20 1315 132 x 142

GNA20 1025 105 x 244

M 1:10

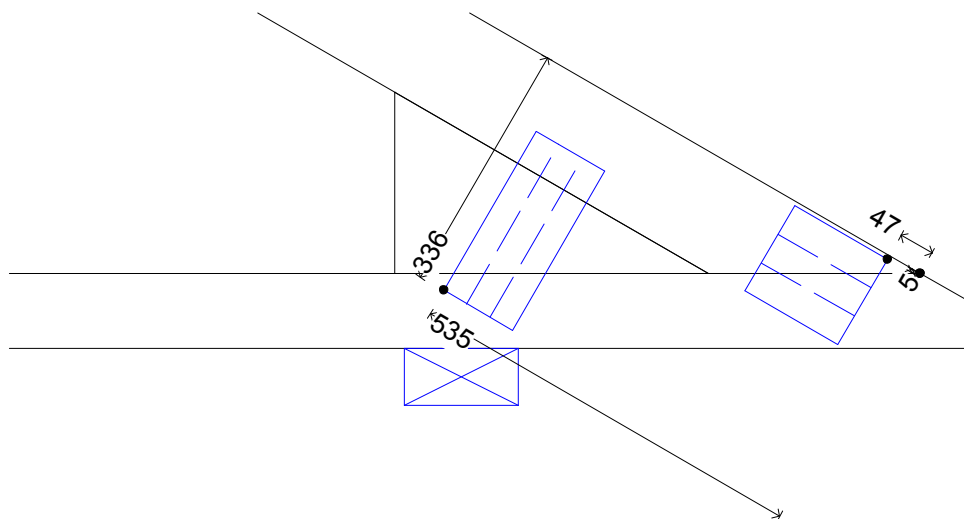

GNA20 1315 132 x 142

GNA20 1025 105 x 244

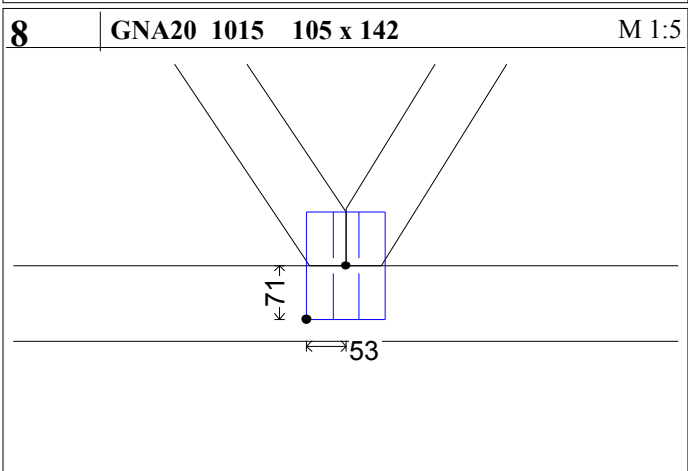
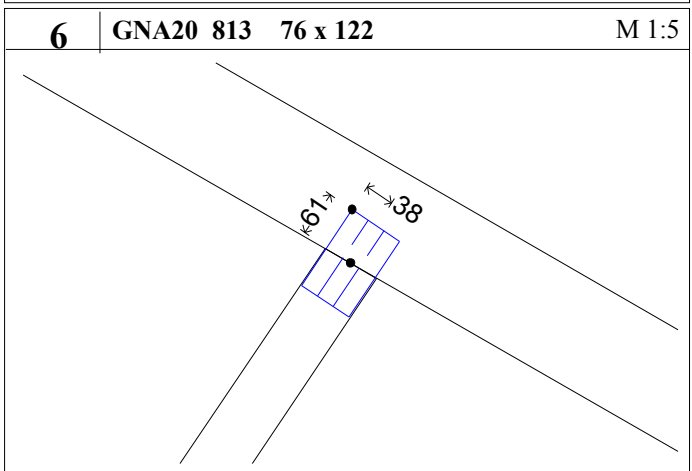
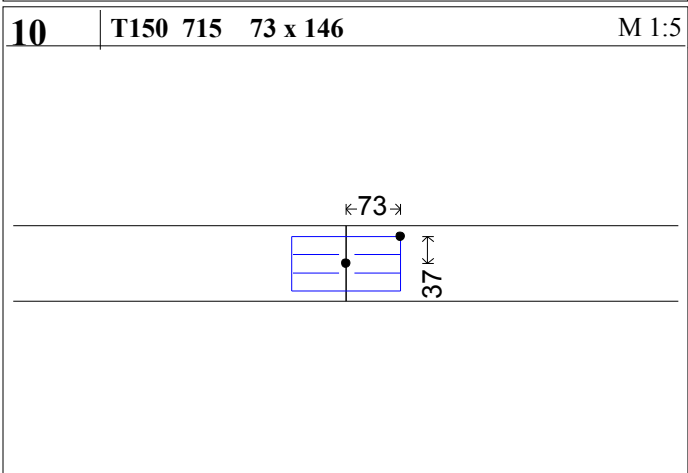
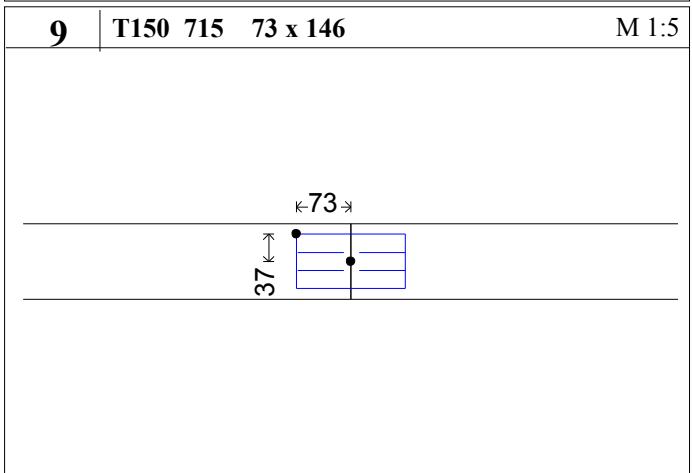
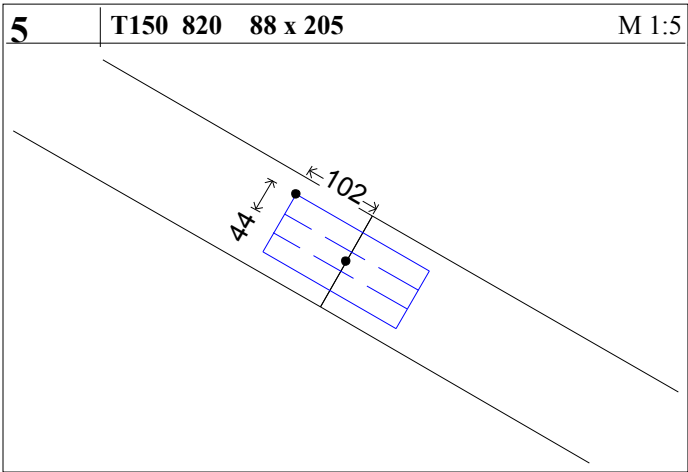
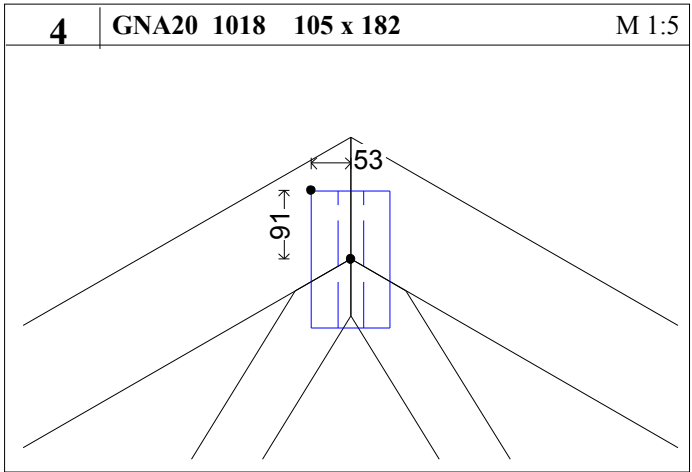
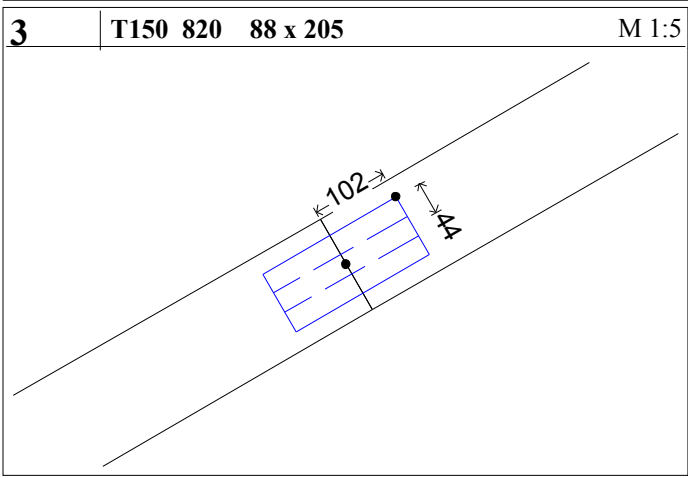
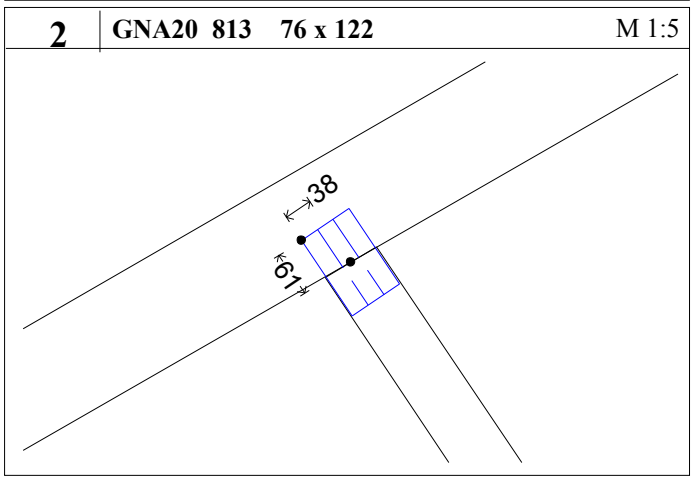

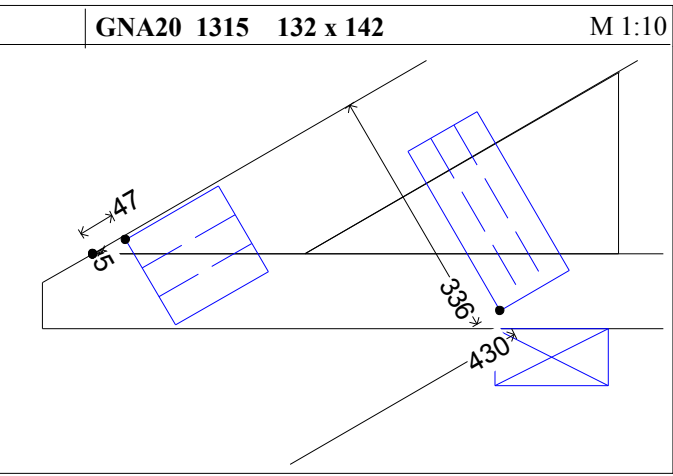
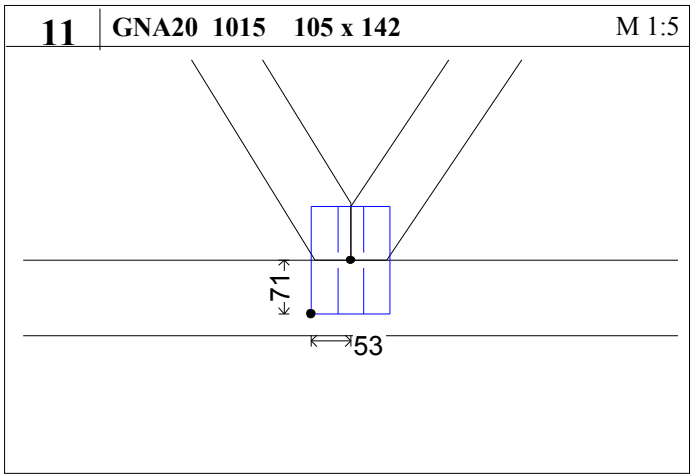



Zakázka : IMRE08

Objednávka č. :

Vazník : GL1

MiTek Industries spol. s

Drážní 7, 627 00 Brno,

Tel.:05-45 51 32 81 Fax05-45 51 32 97

MiTek

Datum : 09.08.2006

Strana : 14

Poč. vrst : 1
Poč. : 6 ks.
Kubatura : 0.1342 m3

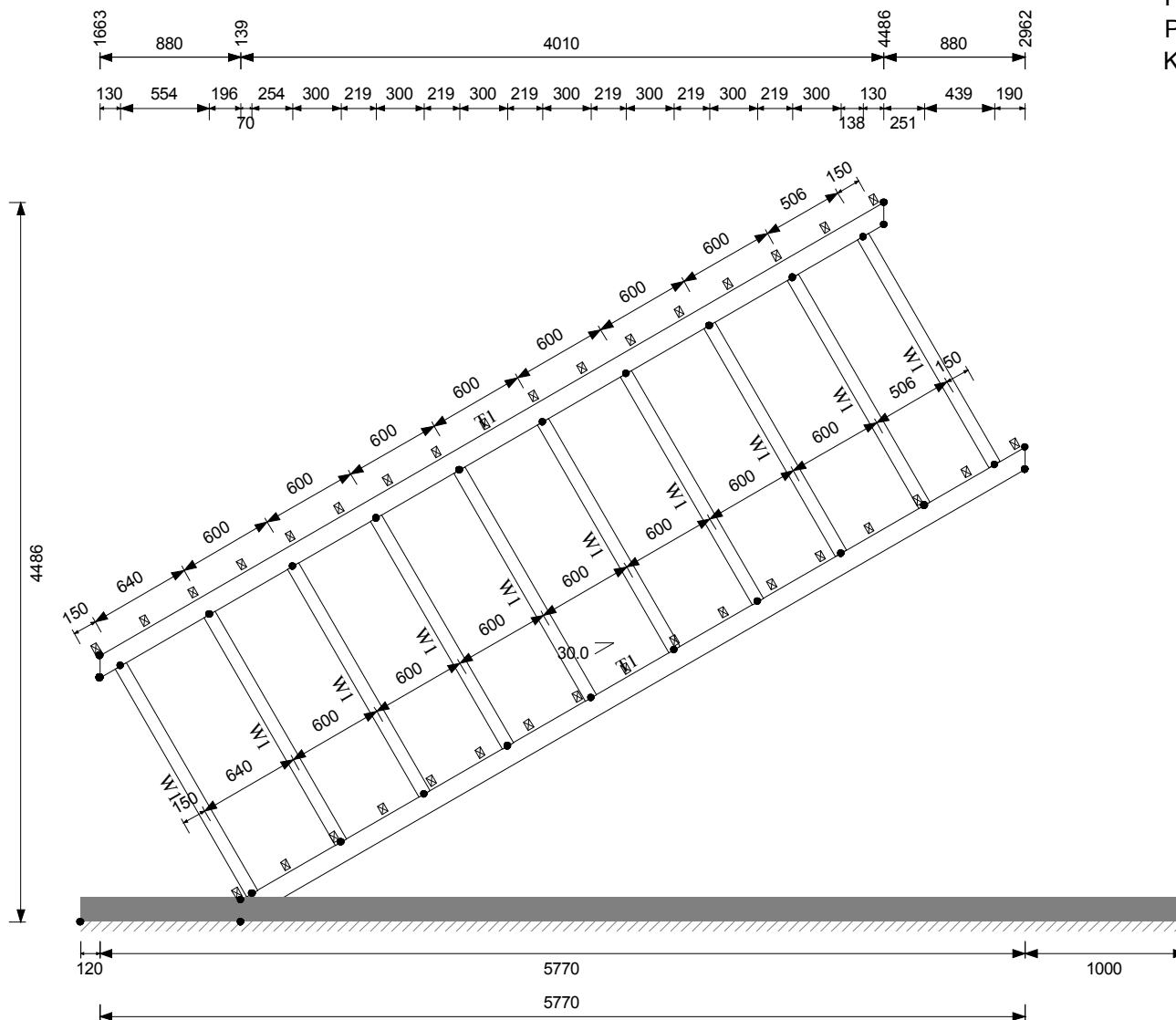

M 1:43

HP 50x120 SM-JD SI;DIAG. 50x80 SM-JD SI;1 - Znás.vaz.

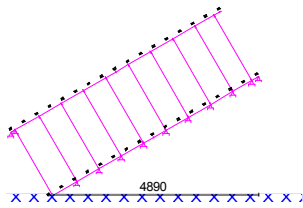

Zakázka : IMRE08

Vazník : **GL1**

Objenávka č.

Datum : 09.08.2006

Celková kubatura : 0.9120 m³

Počet vazníků : 6

Kubatura dřeva na vazník : 0.1520 m³

Prvek : **T1**

30.00

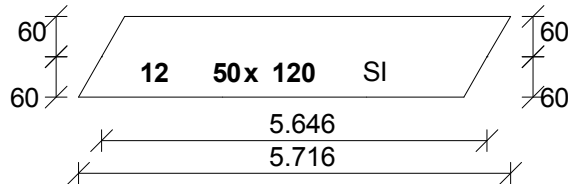

-30.00

Skladová délka : 6.000 metru.

Prvek : **W1**

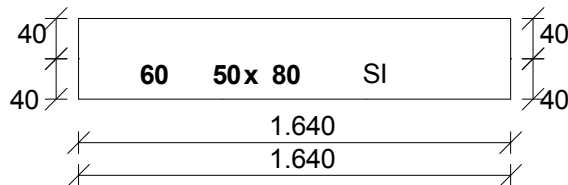

Skladová délka : 2.000 metru.

Zakázka: **IMRE08**
Popis zak.:
Zákazník: lavicky

Vaz.: GL1

MiTek Industries spol. s r.o.

Drážní 7, 627 00 Brno,

Tel.: 05-45 51 32 81

Fax.: 05-45 51 32 97



Strana:

M 1:140

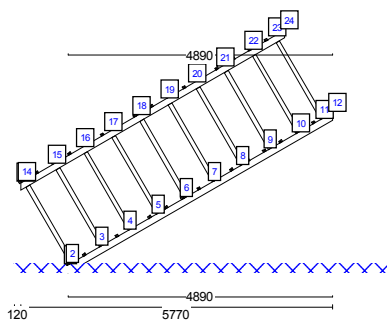

Detaily spojů

Vaz.: GL1

Popis zak.:

Tl. řeziva: 50 mm
Rozteč vaz.: 1,000 mm
Počet vrstev: 1
Počet vaz.: 6

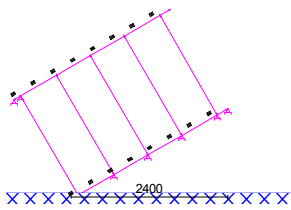

Zakázka : IMRE08

Vazník : **GL2**

Objenávka č.

Datum : 09.08.2006

Celková kubatura : 0.1520 m³

Počet vazníků : 2

Kubatura dřeva na vazník : 0.0760 m³

Prvek : **T1**

30.00

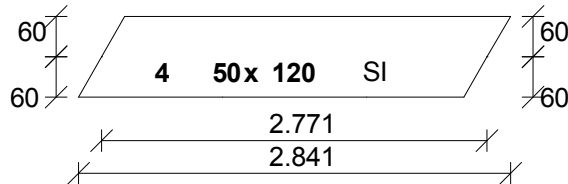

-30.00

Skladová délka : 3.000 metru.

Prvek : **W1**

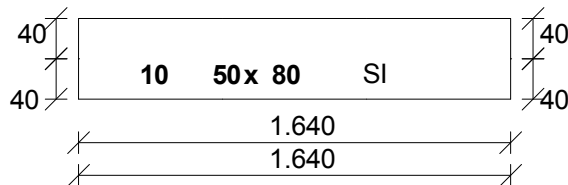

Skladová délka : 2.000 metru.

Zakázka: **IMRE08**
Popis zak.:
Zákazník: **lavicky**

Vaz.: GL2

MiTek Industries spol. s r.o.

Drážní 7, 627 00 Brno,

Tel.: 05-45 51 32 81

Fax.: 05-45 51 32 97



Strana:

M 1:95

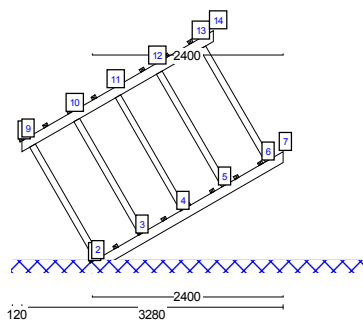

Detaily spojů

Vaz.: GL2

Popis zak.:

Tl. řeziva:	50 mm
Rozteč vaz.:	1,000 mm
Počet vrstev:	1
Počet vaz.:	2



Zakázka : IMRE08
Datum : 09.08.2006

Objednávka č. :

Vazník : WB00

Strana : 20

MiTek Industries spol. s
Dražní 7, 627 00 Brno,
Tel.:05-45 51 32 81 Fax05-45 51 32 97

Poč. vrst : 1
Poč. : 4 ks.
Kubatura : 0.0836 m3

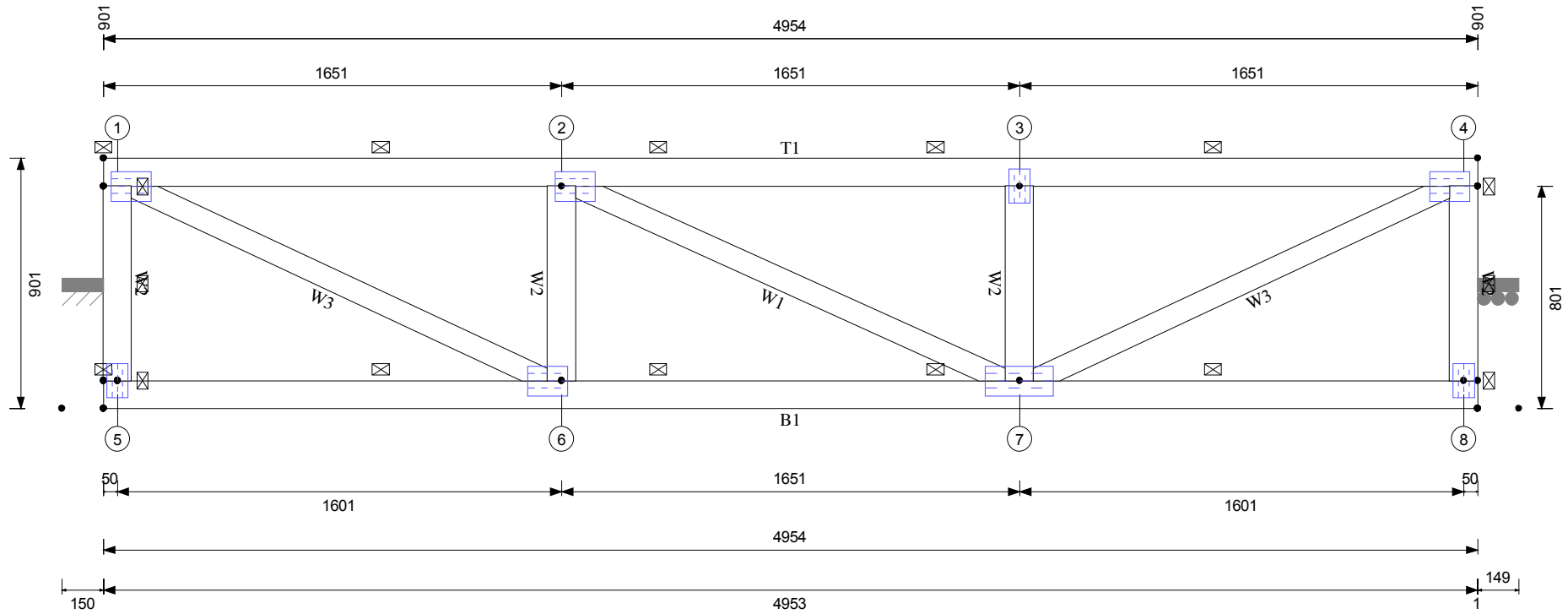

M 1:23

HP 50x100 SM-JD SI;DP 50x100 SM-JD SI;Vlevo EV 50x100 SM-JD SI;Vpravo EV 50x100 SM-JD SI;DIAG. 50x80 SM-JD SI;DIAG. W2, W 2 50x100 SM-JD

Zakázka : IMRE08

Vazník : **WB00**

Objenávka č.

Datum : 09.08.2006

Celková kubatura : 0.3600 m³

Počet vazníků : 4

Kubatura dřeva na vazník : 0.0900 m³

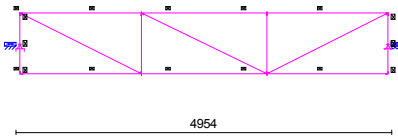

Prvek : **T1**

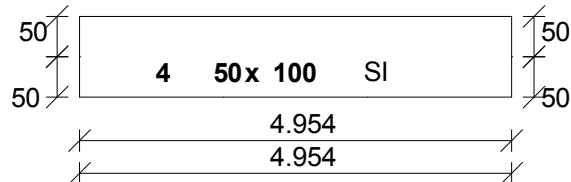

Skladová délka : 5.000 metru.

Prvek : **B1**

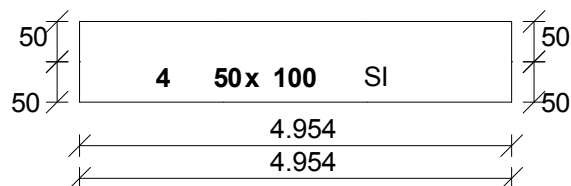

Skladová délka : 5.000 metru.

Prvek : **W1**

65.68

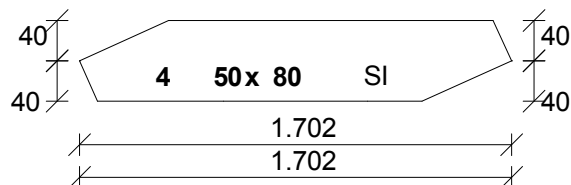

24.32

24.3°

65.7°

Skladová délka : 2.000 metru.

Prvek : **W3**

64.97

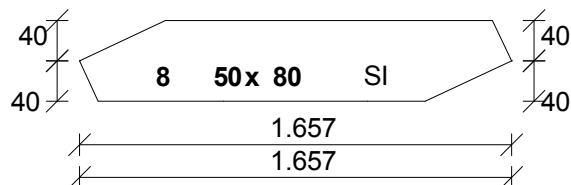

25.03

25.0°

65.0°

Skladová délka : 2.000 metru.

Prvek : **W2**

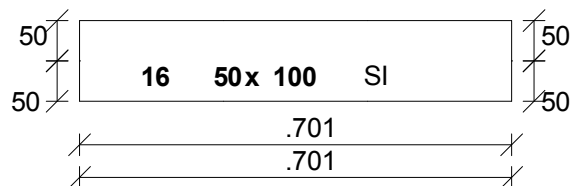

Skladová délka : .800 metru.

M 1:67

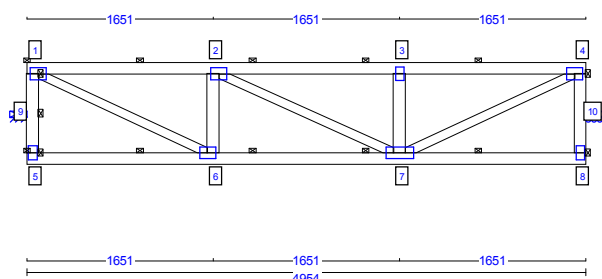

Detaily spojů

Vaz.: **WB00**

Popis zak.:

Tl. řeziva: 50 mm
 Rozteč vaz.: 1,000 mm
 Počet vrstev: 1
 Počet vaz.: 4

1 | GNA20 1015 105 x 142 | M 1:5

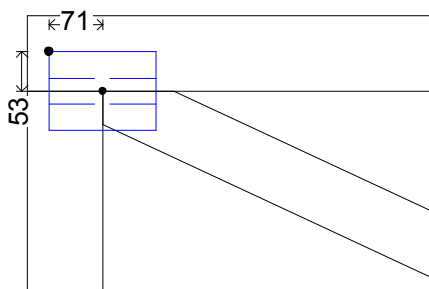

2 | GNA20 1015 105 x 142 | M 1:5

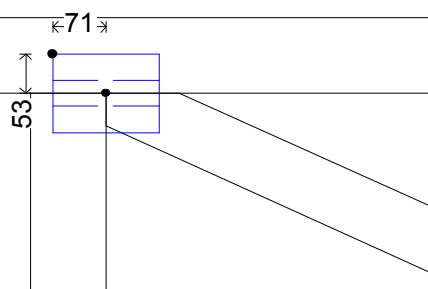

3 | GNA20 813 76 x 122 | M 1:5

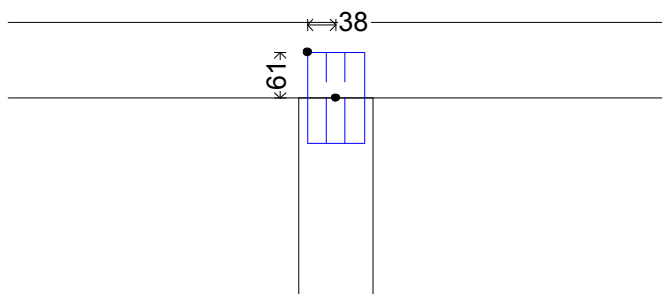

4 | GNA20 1015 105 x 142 | M 1:5

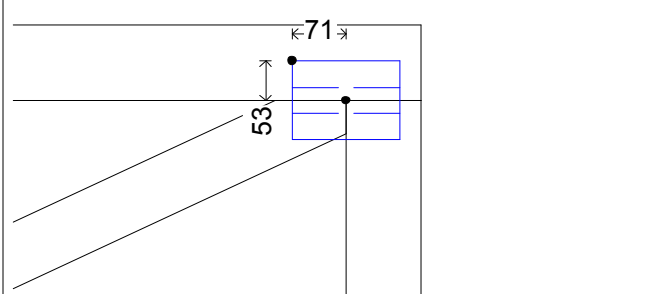

5 | GNA20 813 76 x 122 | M 1:5

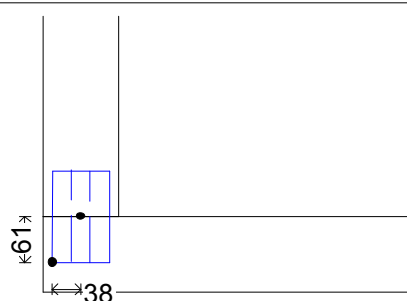

6 | GNA20 1015 105 x 142 | M 1:5

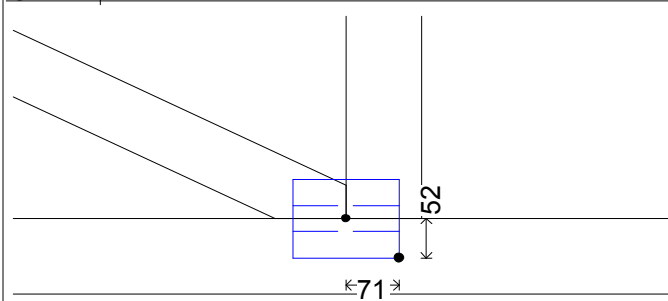

Zakázka: **IMRE08** Vaz.: WB00
Popis zak.:
Zákazník: lavicky

MiTek Industries spol. s r.o.
Drážní 7, 627 00 Brno,
Tel.: 05-45 51 32 81 Fax.: 05-45 51 32 97

Strana:

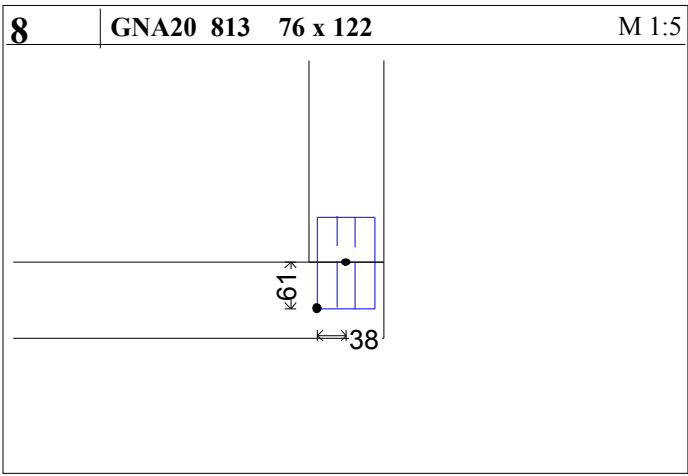
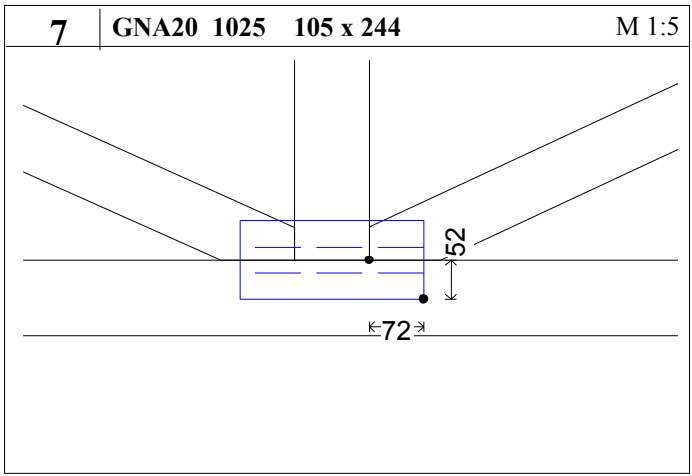

Zakázka : IMRE08

Vazník : **WB01**

Objenávka č.

Datum : 09.08.2006

Celková kubatura : 0.5400 m³

Počet vazníků : 6

Kubatura dřeva na vazník : 0.0900 m³

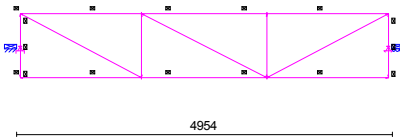

Prvek : **T1**

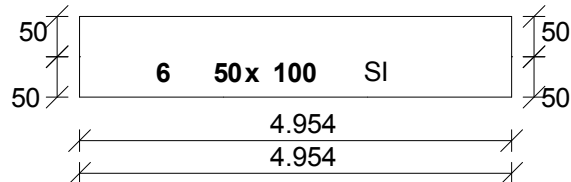

Skladová délka : 5.000 metru.

Prvek : **B1**

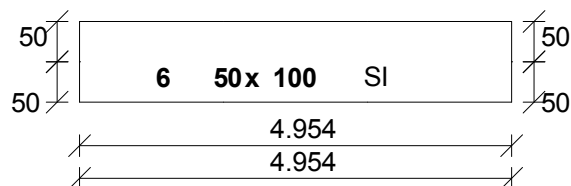

Skladová délka : 5.000 metru.

Prvek : **W1**

25.64

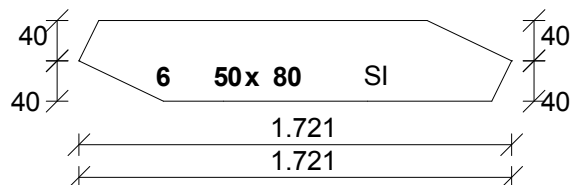

64.36

64.4°

25.6°

Skladová délka : 2.000 metru.

Prvek : **W3**

63.62

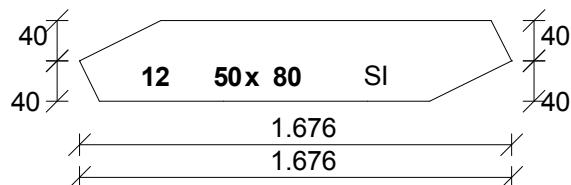

26.38

26.4°

63.6°

Skladová délka : 2.000 metru.

Prvek : **W2**

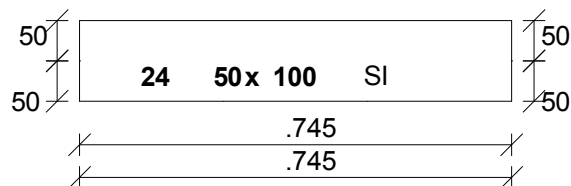

Skladová délka : .800 metru.

Zakázka: **IMRE08**
Popis zak.:
Zákazník: **lavicky**

Vaz.: **WB01**

MiTek Industries spol. s r.o.
Dražní 7, 627 00 Brno,
Tel.: 05-45 51 32 81 Fax.: 05-45 51 32 97



Strana:

M 1:67

Detaily spojů

Vaz.: **WB01**

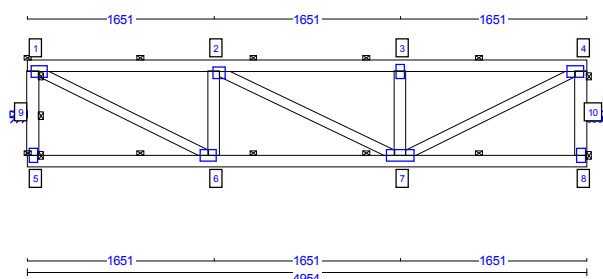

Popis zak.:

Tl. řeziva: 50 mm
Rozteč vaz.: 1,000 mm
Počet vrstev: 1
Počet vaz.: 6

1 | **GNA20 1015 105 x 142** | M 1:5

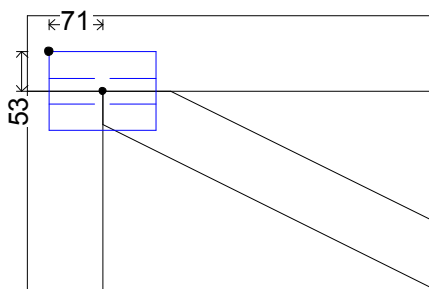

2 | **GNA20 1010 105 x 102** | M 1:5

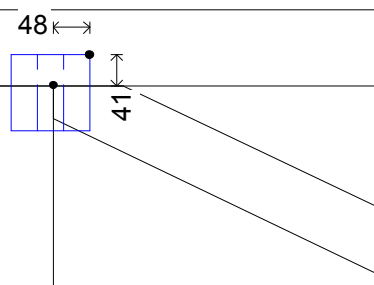

3 | **GNA20 813 76 x 122** | M 1:5

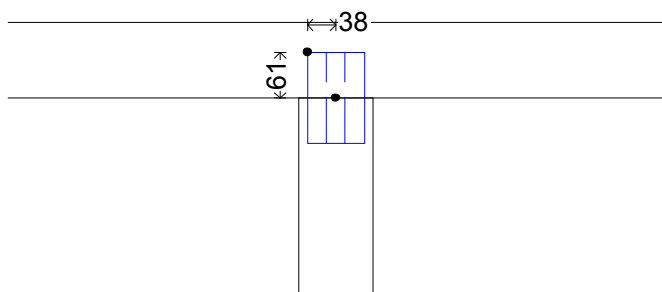

4 | **GNA20 1015 105 x 142** | M 1:5

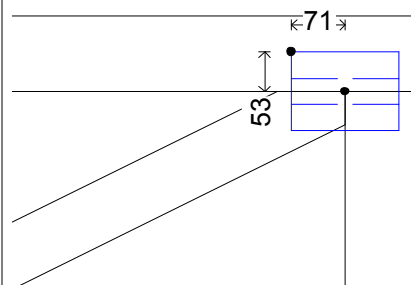

5 | **GNA20 813 76 x 122** | M 1:5

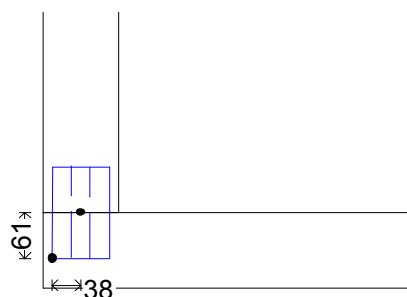

6 | **GNA20 1015 105 x 142** | M 1:5

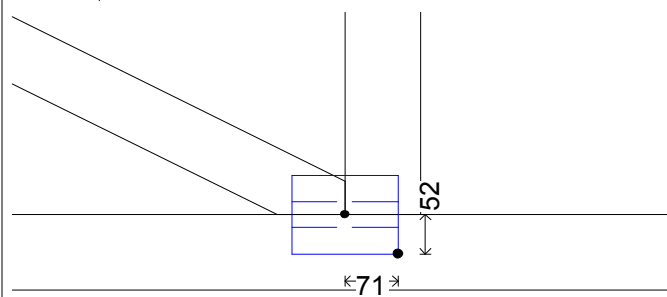

Zakázka: **IMRE08** Vaz.: WB01
Popis zak.:
Zákazník: lavicky

MiTek Industries spol. s r.o.
Drážní 7, 627 00 Brno,
Tel.: 05-45 51 32 81 Fax.: 05-45 51 32 97

Strana:

